

Created by: www.kreativekiste.de	Title: Shuffleboard	Size: A4	Sheet: X / Y	Scale: 0,7
Supplementary information: Die Shuffle müssen durch schieben mit der Hand in ein Tor gebracht werden. Die Tore können Punkte bekommen		Part number: ALL		
		Drawing no.: 1		
		Date: 2018	Revision: REV B	

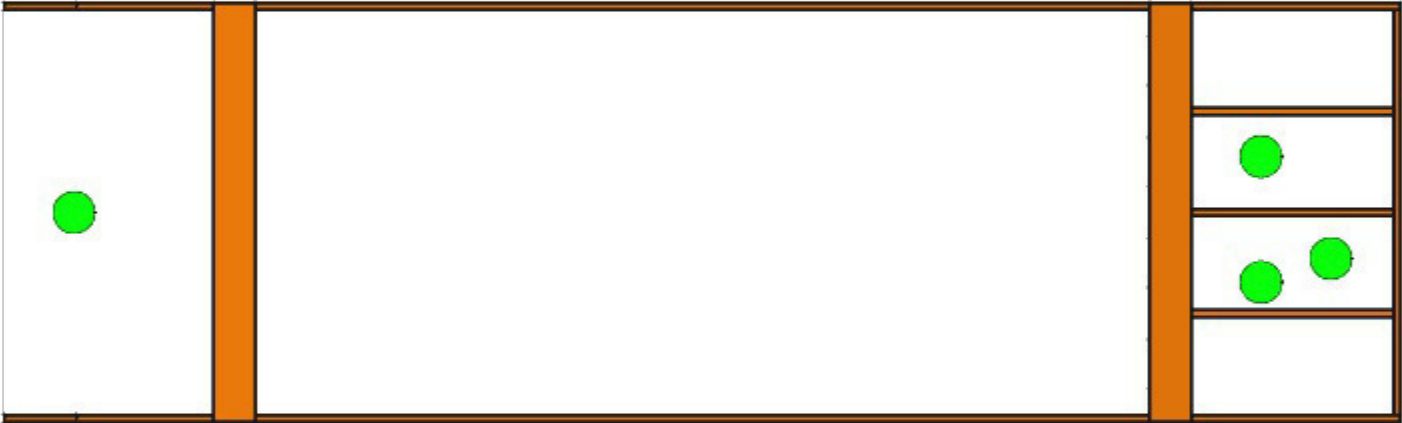

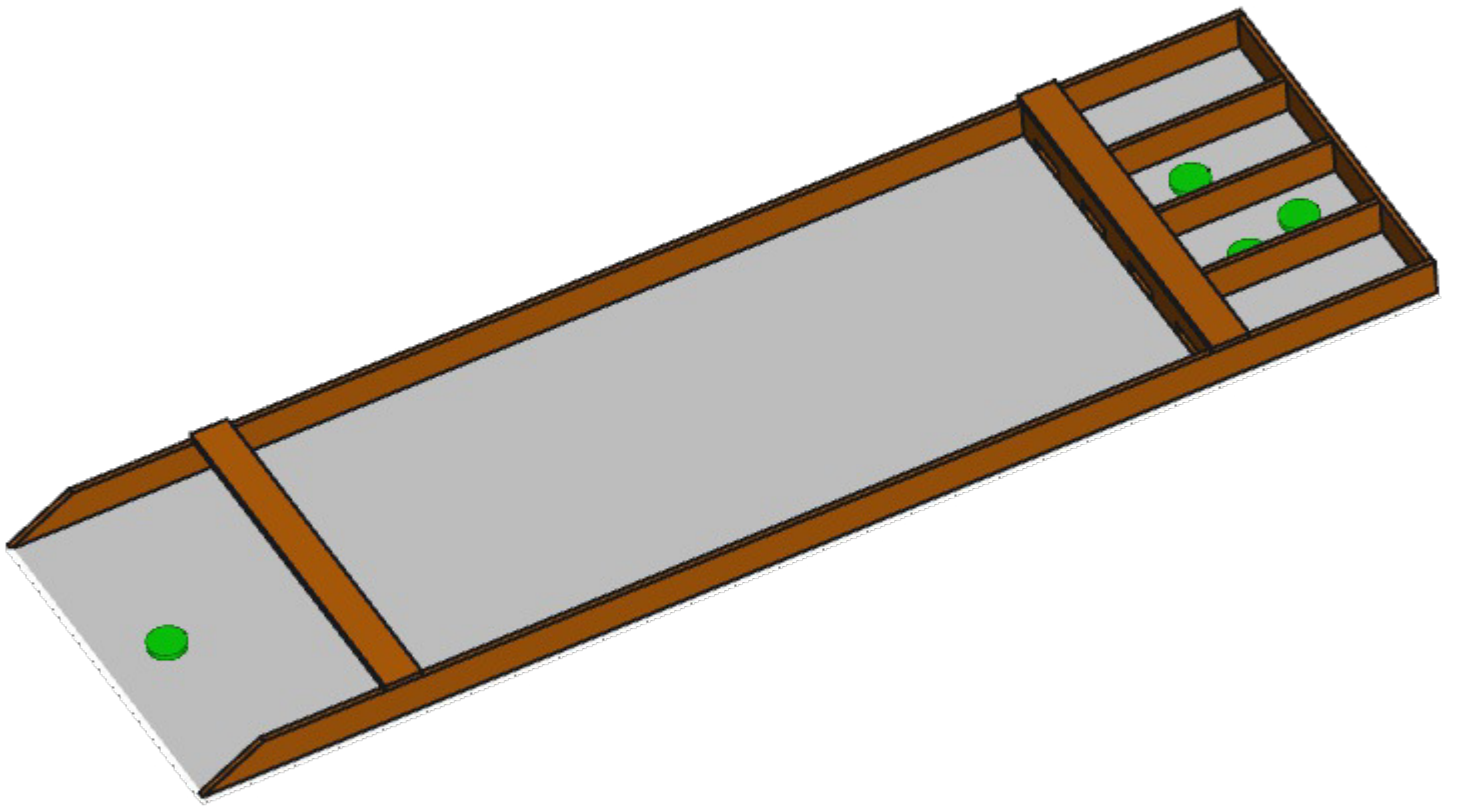

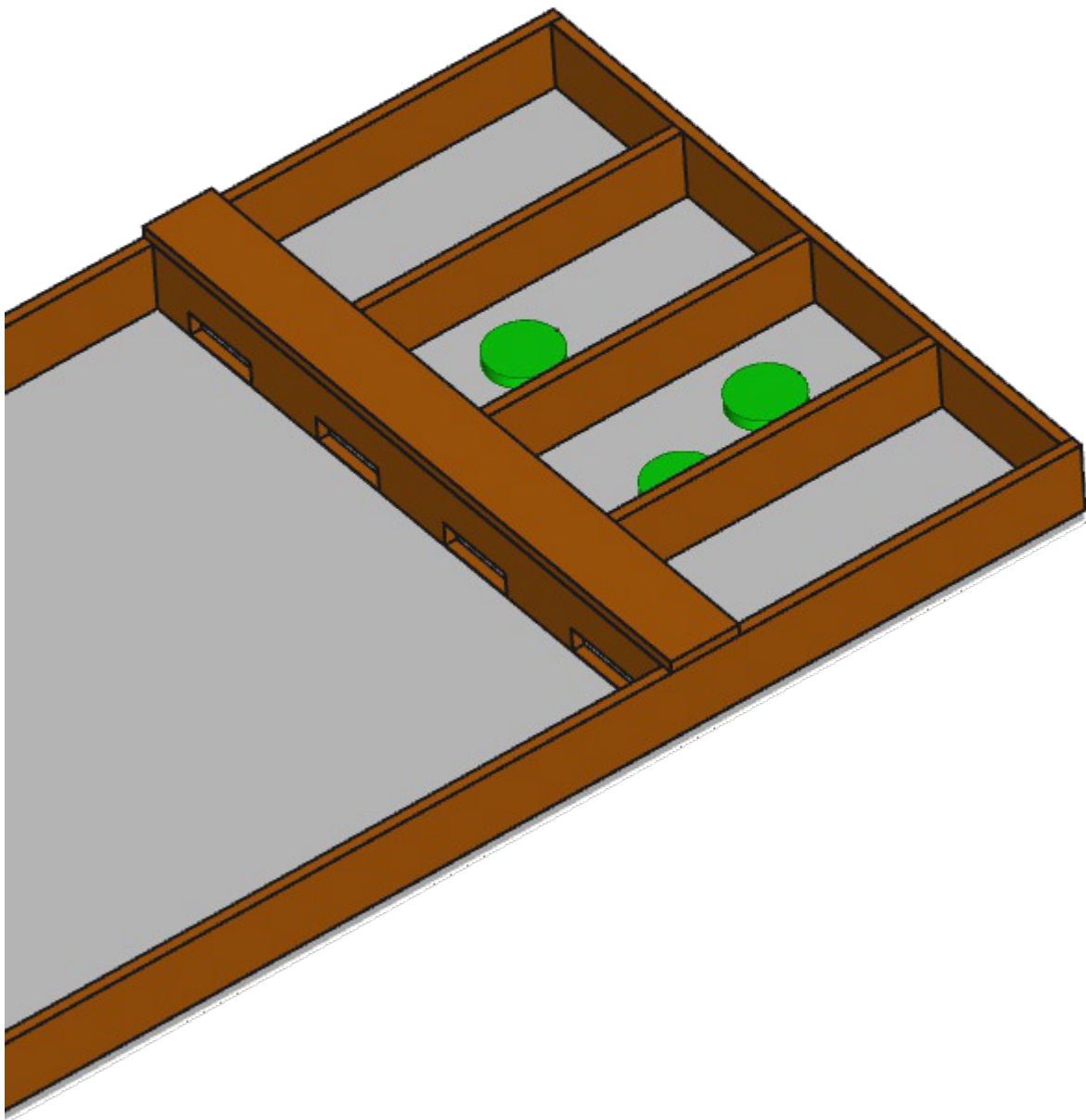



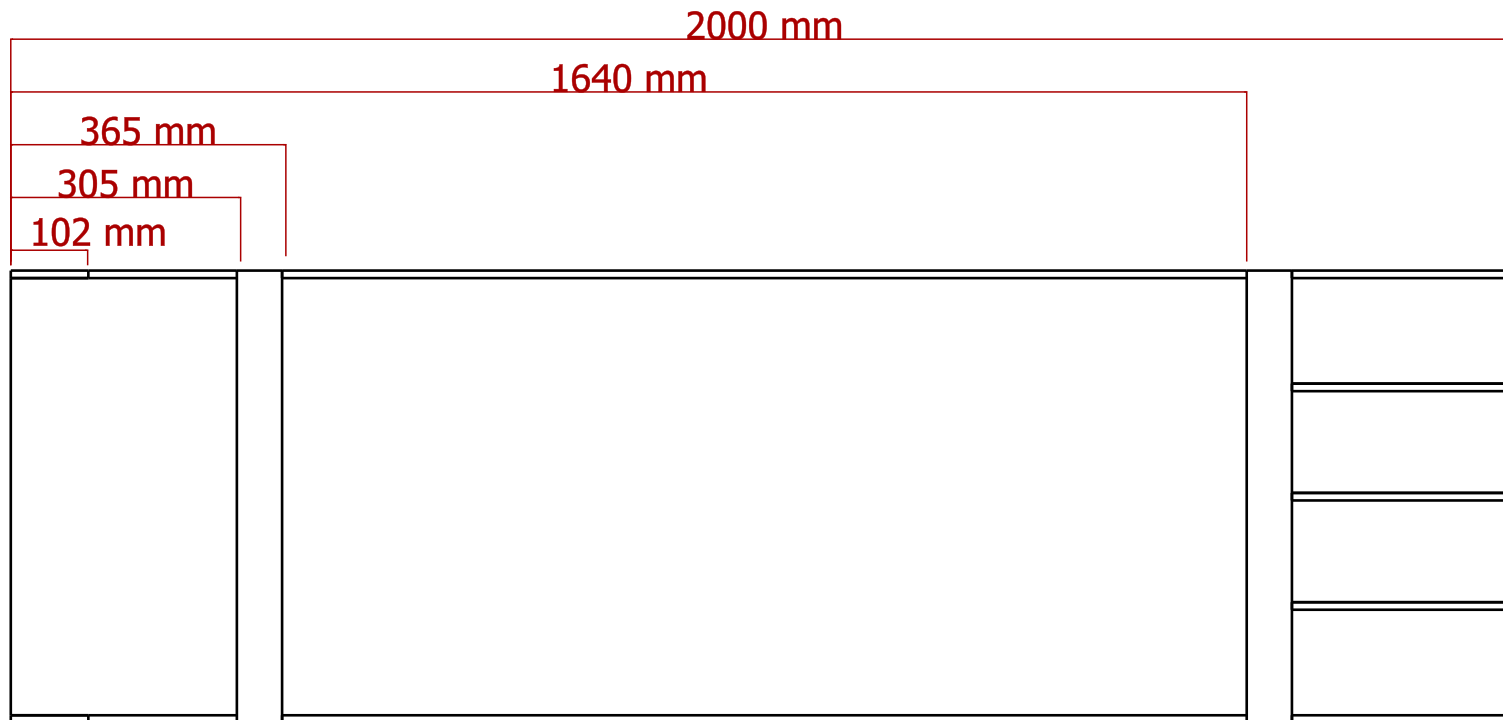



Created by: www.kreativekiste.de	Title: Shuffleboard	Size: A4	Sheet: X / Y	Scale: 0,1
Supplementary information: Shuffelboard Draufsicht		Part number: ALL		
		Drawing no.: 2		
		Date: 2018	Revision: REV A	

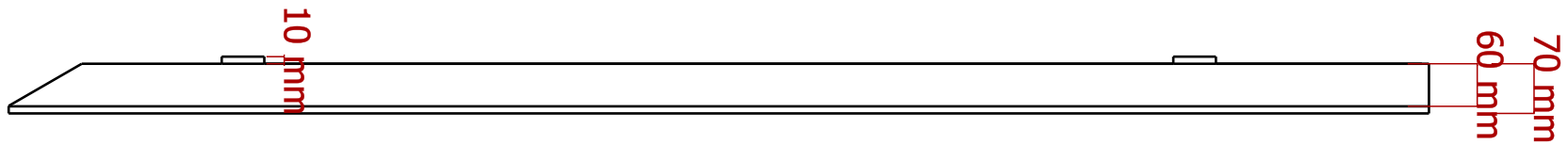



Created by: www.kreativekiste.de	Title: Shuffleboard	Size: A4	Sheet: X / Y	Scale: 0,1
Supplementary information: Shuffelboard Seitenansicht		Part number: ALL		
		Drawing no.: 3		
		Date: 2018	Revision: REV A	

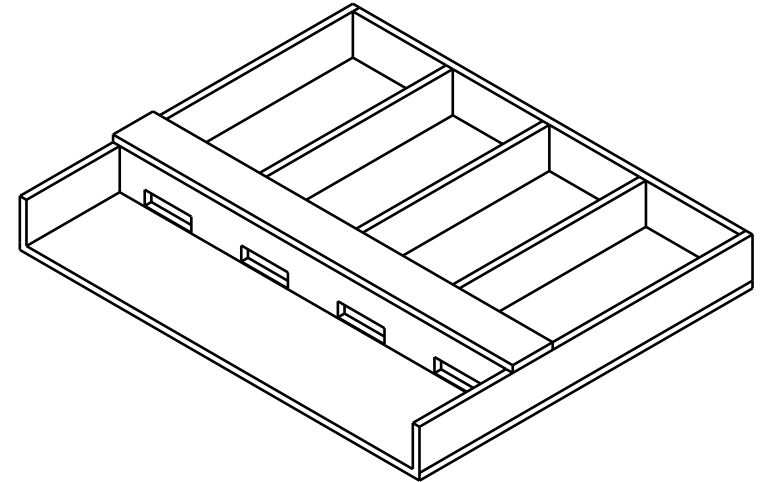
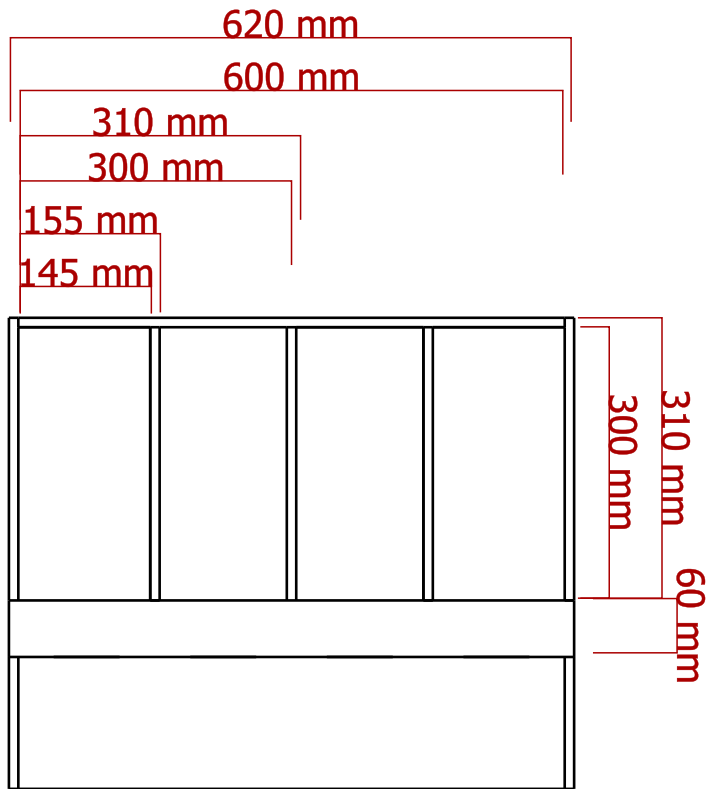

Created by: www.kreativekiste.de	Title: Shuffleboard	Size: A4	Sheet: X / Y	Scale: 0,12
Supplementary information: Shuffeltore		Part number: 3		Revision: REV A
		Drawing no.: 4		
		Date: 2018		



8 Shuffle

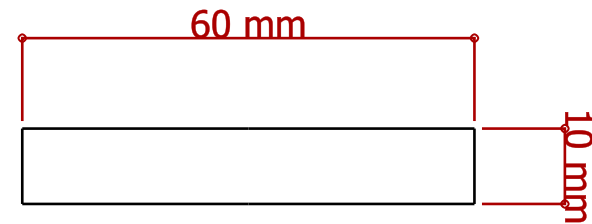
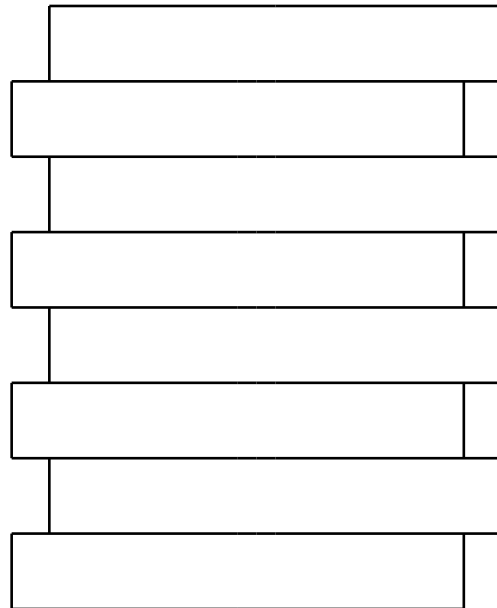

Created by: www.kreativekiste.de	Title: Shuffleboard	Size: A4	Sheet: X / Y	Scale: 1
Supplementary information: Acht Shuffle		Part number: 14		Drawing no.: 5
		Date: 2018	Revision: REV B	

